

LYDIA VOLUME for steelstring guitars

VOLUME CONTROL

GUITAR INTERNAL
PRE-AMPLIFIER
2x3V lithium battery

UNDERSADDLE
TRANSDUCER

END-PIN JACK
ø12mm (1/2")

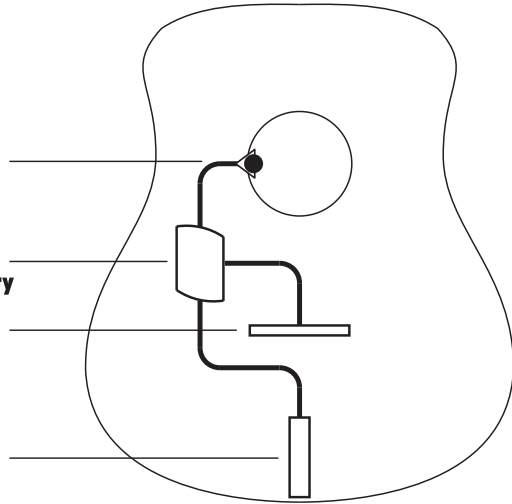

LYDIA FOR STEEL-STRING - POSITIONING

Lydia and SADDLE
FREELY in to the slot

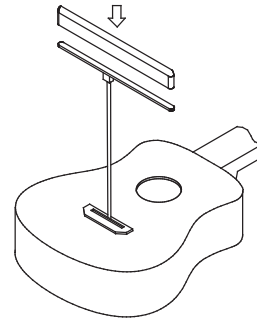

western/steel-string

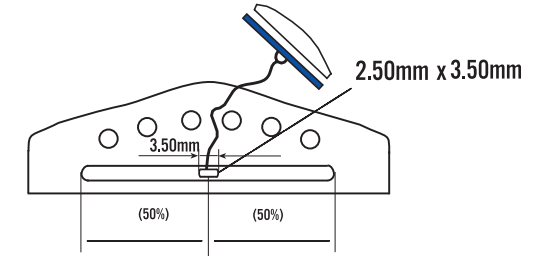

saddle slot :



saddle :



no splinters

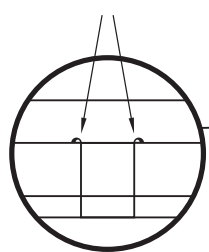

Bluestick : free fitting

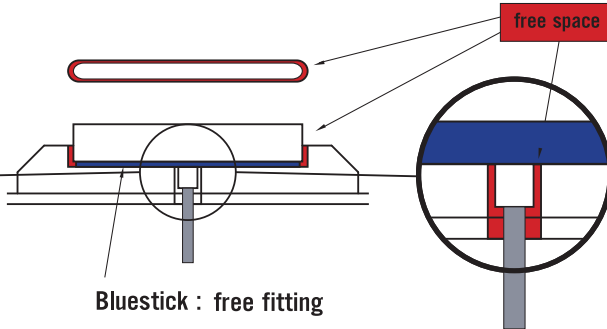

POSITION OF THE SADDLE BY REPLACING OF THE STRINGS

WRONG !

RIGHT !

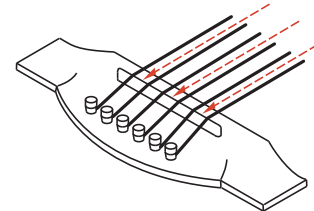
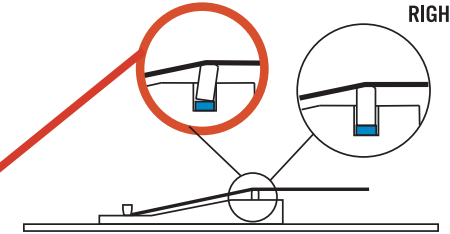

when change strings always
push with a piece of wood to
adjust the balance of the sound